



Installation and Operation Manual

BDM-250-240A

BDM-250-208A

BDM-250-AU

BDM-250-EU

BDM-250-LV



USA

Address: 1781 Riverview Ave., Tracy, CA 95377

Australia

Address: 9 Meander Grove, Cameron Park, NSW2285

China

Address: No.1 Anhe Rd Tsingtao Export Processing Zone, Tsingtao, China 266113

TEL: +86 532 87963900

FAX: +86 532 81100917

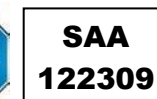

CONTENTS

COMPANY PROFILE	01
1. INTRODUCTION	02
1.1 Prefix	02
1.2 Grid-tied PV System	02
1.3 How to Use This Manual	02
1.4 Label	02
2. SAFETY INSTRUCTION	03
3. FCC COMPLIANCE	03
4. INSTALLATION	04
Parts Included	04
Other Parts and Tools Required	04
Lightning Surge Suppression	04
Installation Procedure	04
Step 1 - Install the AC Branch Circuit Junction Box	05
Step 2 - Attach the BDM-250 to the Racking	06
Step 3 - Connect the BDM-250 Wiring Harnesses	07
Step 4 – Ground the System	08
Step 5 – Complete the connection map and	09
connect the PV Modules	
5. COMMISSIONING	10
6. OPERATING INSTRUCTIONS	11
7. TROUBLRSHOOTING MAINTENANCE	12
8. SPECIFICATION	14
9. WARRANTY AND PRODUCTION INFORMATION	16
WARRANTY CARD	

COMPANY PROFILE

Northern Electric & Power Inc. (NEP) was founded in the United States and has manufacturing and R&D facilities in China. The mission of the company is to develop cutting-edge clean energy technologies and provide state-of-the-art solar inverter products to its customers. The first round of investment to the company was US\$20 Million, with a planned total investment of US\$50 Million. The company is headquartered in the city of Tsingtao, a major industrial center and trading port in the northeastern China. The company campus occupies more than 18 acres in the Tsingtao Export Processing Zone, and has more than 650,000 square feet building space. The campus is planned to be connected through a micro smart grid demo community and powered by electricity from solar, wind and micro turbines. Outside China, the company has operation offices in Chicago, U.S. and Vancouver, Canada.

The technology founders of the company are well-known experts in the fields of power electronics, automatic control, signal processing, and communications. Each of the founders has multiple U.S. and world patents in their specialty areas. They received Ph.D. degrees from top universities in North America, and each has more than 10 years engineering and management experiences in leading U.S. companies.

NEP has a complete product line of grid-tied solar inverters, including 250W~500W micro inverters, 1.5kW~5kW single phase solar inverters, and 10kW~500kW three-phase solar inverters. Field deployment results demonstrated high system efficiency and reliability of NEP solar inverters.

NEP is committed to develop *Clean, Reliable, Affordable and Efficient* (CARE) products for worldwide customers.

1. INTRODUCTION

1.1 Prefix

Dear customer, thank you for choosing the BDM-250 micro inverter from NEP. We hope you will find our products meet your need for renewable energy. Meantime, we appreciate your feedback regarding our products.

1.2 Grid-tied PV System

Grid-tied PV system consists of PV panels, grid-tied inverter and junction boxes. The DC output from the PV panels is converted into AC energy and feedback to the grid through the BDM-250. BDM-250 series PV micro inverter contains isolation transformer with basic insulation between PV input and AC grid output. The PV panel terminals on BDM-250 shall not be earthed via external wiring, for BDM-250 connects PV panel to earth via an internal earth fault interrupting 1A fuse.

1.3 How to Use This Manual







This manual provides detailed product information and installation instructions for the BDM-250 micro solar inverter. Please read through this manual before installation and operation.



WARNING: This indicates a situation where failure to follow instructions may be a safety hazard or cause equipment malfunction. Use extreme caution and follow instructions carefully.

1.4 Label

The label is located on the side of the inverter. The information on the label includes technical data as well as type, firmware version and serial number of the device. Safety instructions on the label are listed and explained below:

	Danger! The term “danger” describes an issue which, if ignored can cause personal injury.
	Attention! With the term “attention” a circumstance is listed which may cause property damage if disregarded.
	Instructions for use! Under “Instructions for Use”, it is pointed out that installation and operating instructions are to be read and understood before installation or repair.
	Caution, hot surface! Under “Caution, hot surface”, it should be noted that surfaces of equipment may be hot and create a burn hazard.
	Special disposal instructions! With “Note Separate Disposal”, it is pointed out that this product may not be disposed of with normal garbage. An improperly conducted disposal can lead to damage to the environment.
	CE mark The product complies with essential requirements of relevant directives of EU.

2. SAFETY INSTRUCTION



WARNING:

PLEASE READ THIS MANUAL BEFORE INSTALLATION. ANY DAMAGE TO THE PRODUCT DUE TO NOT FOLLOWING THIS MANUAL IS NOT COVERED BY THE WARRANTY.

ALL THE INSTALLATION SHOULD BE DONE BY CERTIFIED ELECTRICIAN.

BESIDES THE CABLE CONNECTORS, NOTHING INSIDE THE INVERTER SHOULD BE MODIFIED.

ALL INSTALLATION SHOULD FOLLOW THE LOCAL ELECTRIC CODES. FURTHER PROTECTION ON THE AC WIRING FROM THE INVERTERS SHOULD BE PROVIDED AND MAY BE REQUIRED BY LOCAL AND NATIONAL WIRING REGULATIONS. THIS PROTECTION IS LIKELY TO INCLUDE RESIDUAL CURRENT DEVICES, EARTH FAULT MONITORS AND CIRCUIT BREAKERS. THIS PRODUCT MAY CAUSE AC CURRENT WITH A DC COMPONENT. IF A RESIDUAL CURRENT-OPERATED PROTECTIVE DEVICE (RCD) OR A MONITORING DEVICE (RCM) IS USED FOR PROTECTION IN CASE OF DIRECT OR INDIRECT CONTACT, ONLY AN RCD OR RCM OF TYPE B IS ALLOWED ON THE AC SIDE OF THIS PRODUCT.

NEVER DISCONNECT PV MODULE FROM THE MICRO-INVERTER WITHOUT FIRST ISOLATING THE AC MAINS. ALL PV CONNECTORS AND AC CONNECTORS ARE FORBIDDEN TO BE DISCONNECTED UNDER LOAD BEFORE SWITCHING OFF THE CIRCUIT BREAKER ON THE AC BRANCH.

PLEASE CONTACT AUTHORIZED SERVICE AGENTS FOR ANY SERVICE WORK.

BDM-250 IS A GRID-TIED SOLAR INVERTER. IT MAY REQUIRE APPROVAL FROM LOCAL UTILITY COMPANY TO CONNECT IT TO THE POWER GRID.

BDM-250 DOES NOT INCLUDE COMPONENTS THAT CAN BE SERVED BY CUSTOMERS.



WARNING:

WHEN THE PHOTOVOLTAIC ARRAY IS EXPOSED TO LIGHT, IT SUPPLIES A DC VOLTAGE TO THE MICRO-INVERTER.

3. FCC COMPLIANCE

This equipment has been tested and found to comply with the limits for a Class B digital device, pursuant to part 15 of the FCC Rules. These limits are designed to provide reasonable protection against harmful interference in a residential installation. This equipment generates uses and can radiate radio frequency energy and, if not installed and used in accordance with the instructions, may cause harmful interference to radio communications. However, there is no guarantee that interference will not occur in a particular installation. If this equipment does cause harmful interference to radio or television reception, which can be determined by turning the equipment off and on, the user is encouraged to try to correct the interference by one or more of the following measures:

- Reorient or relocate the receiving antenna.
- Increase the separation between the equipment and the receiver.
- Connect the equipment into an outlet on a circuit different from that to which the receiver is connected.
- Consult the dealer or an experienced radio/TV technician for help.

Changes or modifications not expressly approved by the party responsible for compliance may void the user’s authority to operate the equipment.

4. INSTALLATION

WARNING: BE AWARE THAT INSTALLATION OF THIS EQUIPMENT INCLUDES RISK OF ELECTRIC SHOCK. NORMALLY GROUNDED CONDUCTORS MAY BE UNGROUNDED AND ENERGIZED WHEN A GROUND FAULT IS INDICATED.

Parts Included

In addition to the micro inverters, PV modules, racking, and associated hardware, you'll need the BDM-250 installation kit. This kit includes the following items:

- Protective end cap
- Mounting Bracket (adapter plate)
- AC interconnect cable and protective end CAP

Other Parts and Tools Required

In addition to your PV array and its associated hardware, you will need the following parts:

- Junction box
- Continuous grounding conductor, grounding washers
- Number 2 Phillips screwdriver
- Sockets, wrenches for mounting hardware
- Torque wrench
- Mounting hardware suitable for module racking

Lightning Surge Suppression

Lightning does not actually need to strike the equipment or building where PV system is installed to cause damage. Often, a strike nearby will induce voltage spikes in the electrical grid that can damage equipment. BDM-250 has integrated surge protection, greater than most string inverters. However, if the surge has sufficient energy, the protection built into the BDM-250 can be exceeded, and the equipment can be damaged.

Since the NEP Limited Warranty does not cover "acts of God" such as lightning strikes, and since lightning strikes can occur anywhere, it is best practice to install surge protection as part of any solar installation. Installation of surge protection devices should follow vendor instructions.

Installation Procedure

WARNING: DO NOT CONNECT BDM-250 TO THE UTILITY GRID OR ENERGIZE THE AC CIRCUIT(S) UNTIL YOU HAVE COMPLETED ALL OF THE INSTALLATION PROCEDURES AS DESCRIBED IN THE FOLLOWING SECTIONS.

Installing the BDM-250 Micro inverter System involves several key steps:

1. Measuring service and installing the AC branch circuit junction box.
2. Attaching the BDM-250 Micro inverter to the racking.
3. Connecting the BDM-250 Micro inverter wiring harnesses.
4. Grounding the system.
5. Completing the BDM-250 Micro inverter installation map and connecting the PV modules.

The finished system should be similar as in the diagram. Detailed installation steps are listed in the following section.

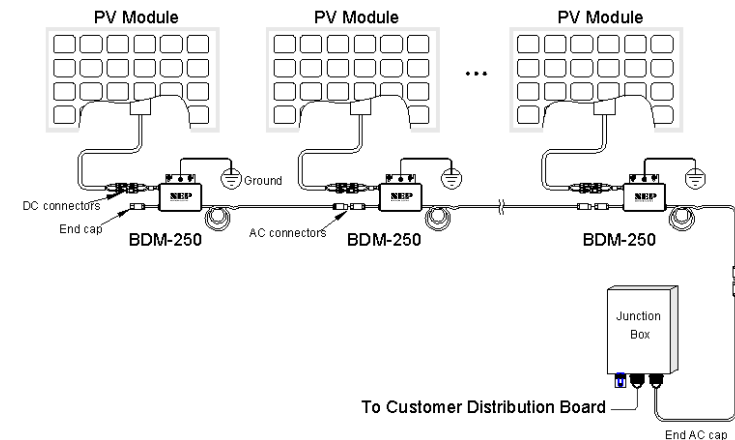

Step 1 - Install the AC Branch Circuit Junction Box

1. Measure service entrance conductors to confirm AC service at the site. Acceptable ranges are shown in the table below:

- BDM-250-240A & BDM-250-208A (North America)

240 Volt AC Single Phase		208 Volt AC Single Phase	
L1(red) to L2(black)	211 to 264 Vac	L1(red) to L2(black)	183 to 229 Vac
L1(red), L2(black) to neutral(blue)	106 to 132 Vac	L1(red), L2(black) to neutral(blue)	106 to 132 Vac

- BDM-250-AU (Australia and New Zealand), BDM-250-EU (Europe)

L1(red)to L2(black)	200 to 270 Vac
---------------------	----------------

- BDM-250-LV (U.S. and Mexico)

L1/L2(red) to N(black)	127 Vac
------------------------	---------

2. Mount the adapter plate at a suitable location on the PV racking system (typically at the end of a row of modules).
3. Install an appropriate junction box with the adapter plate.
4. Connect the open wire end of the AC interconnect cable into the junction box using an appropriate gland or strain relief fitting. The AC interconnect cable requires a strain relief connector with an opening of 3/8 inches in diameter.

Step 2 - Attach the BDM-250 to the Racking

1. Mark the approximate centers of each PV module on the racking system. Evaluate the location of the micro inverter with respect to the PV module junction box or any other obstructions.

WARNING: ALLOW A MINIMUM OF .75 INCHES BETWEEN THE TOP OF THE ROOF AND THE BOTTOM OF BDM-250. WE ALSO RECOMMEND THAT YOU ALLOW .50 INCHES BETWEEN THE BACK OF THE PV MODULE AND THE TOP OF BDM-250. DO NOT MOUNT BDM-250 IN A LOCATION THAT ALLOWS LONG-TERM EXPOSURE TO DIRECT SUNLIGHT.

2. If using grounding washers (e.g., WEEB) to ground the micro inverter chassis to the PV module racking, choose a grounding washer that is approved for the racking manufacturer. Install a minimum of one grounding washer per micro inverter. Torque the micro inverter fasteners to the values listed below.
 1/4" mounting hardware – 45 inlbs minimum
 5/16" mounting hardware – 80 inlbs minimum
3. Mount one micro inverter at each of these locations using hardware recommended by your module racking vendor. Mounting slots on the micro inverter are 0.33 inches in diameter. Maximum bolt size is 5/16 inch. The two slots on the micro inverter are 4 inches apart.

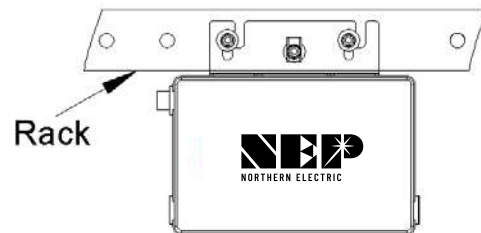

Step 3 - Connect the BDM-250 Wiring Harnesses

Each BDM-250 comes with one 3-pin bulkhead receptacle (or short pigtail) and one 70-inch AC wire harness with multi-pin connectors. (The DC input wires are approximately six inches long and are terminated with single pole connectors.) The AC connectors are oppositely sexed, so that multiple inverters can be connected to form one continuous AC branch circuit.

1. Orient the first BDM-250 in each branch with its male connector facing the junction box. The junction box AC interconnect cable has a female connector. The BDM-250 can be mounted with either side facing up to accommodate cable routing. Connect the first BDM-250 to the AC interconnect cable.
2. Plug the AC connector of the first BDM-250 into the connector of the next BDM-250, and so forth, to form a continuous AC branch circuit. Please check the BDM-250 rating label for the maximum allowable number of BDM-250 on one AC branch circuit. For the chain of the BDM-250 micro inverters thus formed, one end of the AC cable should be protected by a CAP (refer to the BDM-250 accessories). For the other end of the AC cable, it should be connected to an AC junction box through a tail cable (refer to the BDM-250 accessories). For BDM-250-240A and BDM-250-208A, the L1 wire (red), L2 wire (black) and neutral wire (blue) in the AC cable should be connected to the corresponding phases of the main grid through the AC junction box. For BDM-250-AU and BDM-250-EU, the L1 wire (red) and L2 wire (black) should be connected to the L and N phases of the main grid respectively at the AC junction box. For BDM-250-AU and BDM-250-EU, the neutral wire (blue) is unused and should be terminated in the AC junction box on an unused connector. It should NOT be connected to L1 (red), or L2 (black), or earth, or any other wires.

WARNING: DO NOT EXCEED THE MAXIMUM NUMBER OF BDM-250 IN AN AC BRANCH CIRCUIT, AS DISPLAYED ON THE UNIT-RATING LABEL. EACH BDM-250 AC BRANCH CIRCUIT MUST BE SOURCED FROM A DEDICATED BRANCH CIRCUIT PROTECTED BY A 15A MAXIMUM BREAKER.

3. Install a protective end cap on the open AC connector of the last BDM-250 in the AC branch circuit.

WARNING: MAKE SURE PROTECTIVE END CAPS HAVE BEEN INSTALLED ON ALL UNUSED AC CONNECTORS. UNUSED AC BDM-250 WIRE HARNESS CONNECTORS ARE LIVE WHEN THE SYSTEM IS ENERGIZED BY THE UTILITY SYSTEM.

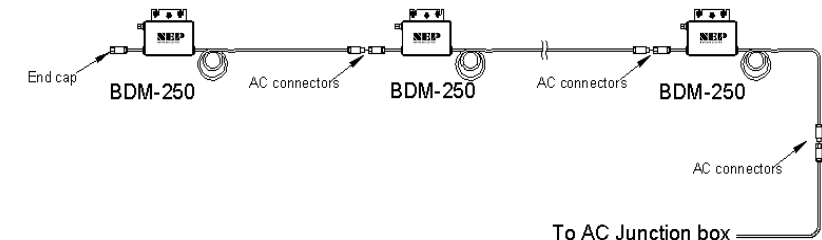

Step 4 – Ground the System

Each BDM-250 comes with a ground clip that can accommodate a 6-8 AWG conductor. If you are not using grounding washers to ground the BDM-250 chassis as described in step 2, route a continuous GEC through each of the BDM-250 to the NEC approved AC grounding electrode. The racking and module could be grounded to this conductor using a crimp connection. An alternative method would be to connect the BDM-250 to the grounded racking using a grounding washer approved for the racking.

NOTE: The neutral wire (blue) in the AC cable is NOT bonded to earth and earth/ground connection is not provided via the AC cable through the micro-inverter. The earth/ground connector on the enclosure of micro-inverter shall be reliably connected to the earth; otherwise there will be a risk of person shock hazard or fire hazard. The ground conductor size is recommended with at least 4mm² and should be larger than live conductor cross section area. Refer to local regulation for minimum size requirement for ground conductor size.

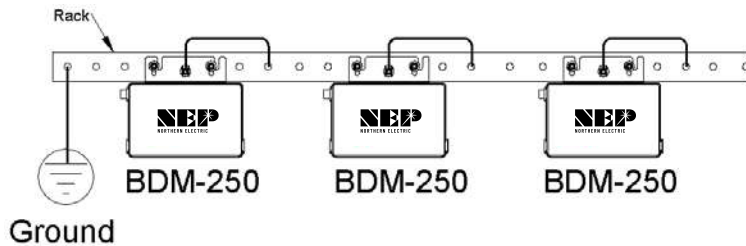

Step 5 – Complete the connection map and connect the PV Modules

BDM-250 connection Map is a diagrammatic representation of the physical location of each BDM-250 in your PV installation. The virtual array in NEP micro inverter gateway BDG-256 is created from the map you create.

Complete the connection map

Each BDM-250 has a removable serial number located on the individual label. Enter the unique address contained in part of the serial number into a BDG-256, and correspond it to a number in the connection map.

Connect the PV Modules

Completely install all BDM-250 and all system inter-wiring connections prior to installing the PV modules.

1. Mount the PV modules above their corresponding BDM-250. Each BDM-250 comes with two oppositely sexed DC connectors.
2. First connect the positive DC wire from the PV module to the positively marked DC connector (male pin) of the BDM-250. Then connect the negative DC wire from the PV module to the negatively marked DC connector (female socket) of the BDM-250. Repeat for all remaining PV modules using one BDM-250 for each module.

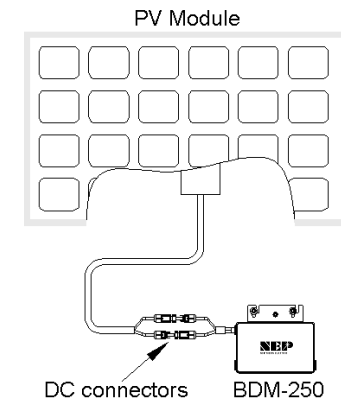

5. COMMISSIONING

 **WARNING:** CONNECT BDM-250 TO THE ELECTRICAL UTILITY GRID ONLY AFTER RECEIVING PRIOR APPROVAL FROM THE UTILITY COMPANY.

 **WARNING:** BE AWARE THAT ONLY QUALIFIED PERSONNEL CAN CONNECT BDM-250 TO THE ELECTRICAL UTILITY GRID.

 **WARNING:** ENSURE THAT ALL AC AND DC WIRING IS CORRECT. ENSURE THAT NONE OF THE AC AND DC WIRES IS PINCHED OR DAMAGED. ENSURE THAT ALL JUNCTION BOXES ARE PROPERLY CLOSED.

Following these steps to commission the BDM-250 PV system:

1. Turn on the AC disconnects or circuit breakers on each BDM-250 AC branch circuit.
2. Turn on the main utility-grid AC circuit breaker. Your system will start producing power after a few minutes wait time.
3. The BDM-250 will start to send performance data over the power lines using power line communication (PLC) to the BDG-256. The time required for each BDM-250 in the system to communicate to the BDG-256 will vary with the number of BDM-250 in the system.

6. OPERATING INSTRUCTIONS

The BDM-250 is powered on when sufficient DC voltage from the module is applied. The status LED will start flashing after sufficient DC power is applied as an indication that the BDM-250 is live.

Status: standby

The LED light is on by 2 second, and off by 2 seconds.

Status: producing power

The LED light is on by 1 second, and off by 1 second.

Status: producing power and communicating with BDG-256

The LED light is on by 0.5 second, and off by 0.5 second.

In case of fault, BDM-250 has multiple protective functions and stops output power. The fault message may be sent to a connected BDG-256 gateway through power line communication. The error message is displayed on the screen of BDG-256 gateway by a 16-bit error code.

Error code	Error
Bit-0	DC over voltage
Bit-1	DC under voltage
Bit-2	hardware error
Bit-3	Inverter over voltage
Bit-4	Frequency over
Bit-5	Frequency under
Bit-6	AC voltage RMS over
Bit-7	AC voltage RMS under
Bit-8	Peak AC voltage over
Bit-9	AC current RMS over
Bit-10	Peak AC current over
Bit-11	Temperature over
Bit-12	ADC error
Bit-13	GFDI fault indicator
Bit-14	Relay fault (BDM-250-AU/BDM-250-EU only)
Bit-15	PLC Communication Error

7. TROUBLESHOOTING AND MAINTENANCE

 **WARNING:** DO NOT ATTEMPT TO REPAIR THE BDM-250; IT CONTAINS NO USER-SERVICEABLE PARTS. IF TROUBLESHOOTING METHODS FAIL, PLEASE RETURN THE BDM-250 TO YOUR DISTRIBUTOR FOR MAINTENANCE.

 **WARNING:** NEVER DISCONNECT THE DC WIRE CONNECTORS UNDER LOAD. ENSURE THAT NO CURRENT IS FLOWING IN THE DC WIRES PRIOR TO DISCONNECTING. AN OPAQUE COVERING MAY BE USED TO COVER THE MODULE PRIOR TO DISCONNECTING

 **WARNING:** ALWAYS DISCONNECT AC POWER BEFORE DISCONNECTING PV MODULE WIRES FROM BDM-250. THE AC CONNECTOR OF THE FIRST BDM-250 IN A BRANCH CIRCUIT IS SUITABLE AS A DISCONNECTING MEANS ONCE THE AC BRANCH CIRCUIT BREAKER IN THE LOAD CENTER HAS BEEN OPENED.

 **WARNING:** BDM-250 IS POWERED BY DC POWER FROM PV MODULES. MAKE SURE YOU DISCONNECT THE DC CONNECTIONS AND RECONNECT DC POWER TO WATCH FOR THE TWO SECONDS LED ON AND TWO SECONDS LED OFF AFTER DC IS APPLIED.

LED indication of error

- **Error report: AC or DC fault**
The LED light is on by 4 second, and off by 4 seconds.
- **Error report: GFDI fault**
The LED light stays on.

Troubleshooting an inoperable BDM-250

To troubleshoot an inoperable BDM-250, follow the steps in the order shown:

1. Check the connection to the utility grid. Verify that the utility voltage and frequency are within allowable ranges shown in the label of BDM-250.
2. Verify utility power is present at the inverter in question by removing AC, then DC power. Never disconnect the DC wires while the BDM-250 is producing power. Re-connect the DC module connectors, and then watch for the LED blinks.
3. Check the AC branch circuit interconnection harness between all the BDM-250. Verify that each inverter is energized by the utility grid as described in the previous step.
4. Make sure that any AC disconnects are functioning properly and are closed.
5. Verify the PV module DC voltage is within the allowable range shown in the label of BDM-250.
6. Check the DC connections between the BDM-250 and the PV module.
7. If the problem persists, please call customer support at NEP.

WARNING: DO NOT ATTEMPT TO REPAIR THE BDM-250; IT CONTAINS NO USER-SERVICEABLE PARTS. IF TROUBLESHOOTING METHODS FAIL, PLEASE RETURN THE BDM-250 TO YOUR DISTRIBUTOR FOR MAINTENANCE.

Disconnecting a BDM-250 from the PV Module

To ensure the BDM-250 is not disconnected from the PV modules under load, adhere to the following disconnection steps in the order shown:

1. Disconnect the AC by opening the branch circuit breaker.
2. Disconnect the first AC connector in the branch circuit.
3. Cover the module with an opaque cover.
4. Using a DC current probe, verify there is no current flowing in the DC wires between the PV module and the BDM-250.
5. Care should be taken when measuring DC currents, most clamp-on meters must be zeroed first and tend to drift with time.
6. Disconnect the PV module DC wire connectors from the BDM-250.
7. Remove the BDM-250 from the PV array racking.

Installing a replacement BDM-250

1. Attach the replacement BDM-250 to the PV module racking using hardware recommended by your module racking vendor. If you are using grounding washers (e.g., WEEB) to ground the chassis of the BDM-250, the old grounding washer should be discarded, and a new grounding washer must be used when installing the replacement BDM-250. Torque the BDM-250 fasteners to the values listed below:
1/4" mounting hardware – 45 in-lbs minimum
5/16" mounting hardware – 80 in-lbs minimum.
2. If you are using a grounding electrode conductor to ground the BDM-250 chassis, attach the grounding electrode conductor to the BDM-250 ground clamp.
3. Connect the AC cable of the replacement BDM-250 and the neighboring BDM-250 to complete the branch circuit connections.
4. Complete the connection map and connect the PV Modules.
 - 1) Complete the connection map
 - 2) Each BDM-250 has a removable serial number located on the individual label. Enter the unique address contained in part of this serial number into a BDG-256, and correspond it to a number in the connection map.
 - 3) Connect the PV Modules
 - 4) Completely install all BDM-250 and all system inter-wiring connections prior to installing the PV modules.
 - a) Mount the PV modules above their corresponding BDM-250. Each BDM-250 comes with two oppositely sexed DC connectors.
 - b) First connect the positive DC wire from the PV module to the positively marked DC connector (male pin) of the BDM-250. Then connect the negative DC wire from the PV module to the negatively marked DC connector (female socket) of the BDM-250. Repeat for all remaining PV modules using one BDM-250 for each module.

8. SPECIFICATION

MODEL		BDM-250-240A	BDM-250-208A
INPUT(DC)	Max Recommended PV Power (Wp)	285	
	Max DC Open Circuit Voltage (Vdc)	60	
	Max DC Input Current (Adc)	12	
	MPPT Tracking Accuracy	>99.5%	
	MPPT Tracking Range (Vdc)	22-55	
OUTPUT(AC)	Rated AC Output Power (Wp)	220	
	Nominal Power Grid Voltage (Vdc)	240 / 220	208/220
	Allowable Power Grid Voltage (Vdc)	211-264/198-253	186-228/198-253
	Allowable Power Grid Frequency (Hz)	59.3-60.5/45.5-52.5	
	THD	<3% (at rated power)	
SYSTEM EFFICIENCY	Peak Efficiency	96.3%	95.70%
	CEC Efficiency	95%	
	Night Time Tare Loss (Wp)	0.17	
PROTECTION FUNCTIONS	Over/Under Voltage Protection	Yes	
	Over/Under Frequency Protection	Yes	
	Anti-Islanding Protection	Yes	
	Over Current Protection	Yes	
	Reverse DC Polarity Protection	Yes	
	GFDI	Integrated	
	Overload Protection	Yes	
	Protection Degree	NEMA-6	
OTHER PARAMETERS	Environment Humidity	100%, condensation	
	Display	LED LIGHT	
	Communications	Power Line	
	Dimension (D-W-H mm)	230*138*35	
	Weight (Kg)	2	

MODEL		BDM-250-EU BDM-250-AU
INPUT(DC)	Max Recommended PV Power (Wp)	285
	Vmax PV (absolute maximum) (Vdc)	60
	PV Input Operating Voltage Range (Vdc)	22-55
	Maximum Operating PV Input Current (Adc)	12
	MPPT Tracking Accuracy	>99.5%
	Isc PV (absolute maximum) (Adc)	14
OUTPUT(AC)	Maximum Inverter Backfeed Current to the Array (Adc)	0
	Rated AC Output Power (W)	220
	Nominal Power Grid Voltage (Vac)	230
	Current (maximum continuous) (Aac)	1.0
	Current (inrush) (Peak and Duration)	12A, 15us
	Nominal Frequency (Hz)	50
	Power Factor (cos phi, fixed)	>0.99
	Maximum Output Fault Current (Aac)	2.2A peak
	Maximum Output Overcurrent Protection (Aac)	6.3
	Maximum Number of Units Per Branch	15
SYSTEM EFFICIENCY	Peak Efficiency	96.30%
	CEC Efficiency	95.0%
	Night Time Tare Loss (Wp)	0.17
PROTECTION FUNCTIONS	Over/Under Voltage Protection	Yes
	Over/Under Frequency Protection	Yes
	Anti-Islanding Protection	Yes
	Over Current Protection	Yes
	Reverse DC Polarity Protection	Yes
	Overload Protection	Yes
	GFDI	Integrated
	Protective Class	I
OTHER PARAMETERS	IP Rating per Part 1	IP67
	Environment Temperature	-40°C ~ +65°C
	Environment Category	Indoor and outdoor
	Wet Location	SUITABLE
	Pollution Degree	PD 3
	Environment Humidity	100%. condensation
	Maximum Altitude	2000 M
	Overvoltage Category	II(PV), III (AC MAINS)
	Display	LED LIGHT
	Communications	POWERLINE
	Dimension (D-W-H mm)	230*138*35
	Weight(Kg)	2
	Product Safety Compliance	IEC/EN 62109-1
	Grid Code Compliance* (Refer to the label for the detailed grid code compliance)	VDE-AR-N 4105* VDE V 0126-1-1/A1 G83/2 AS 4777.2 & AS
Note: For grid code VDE-AR-N 4105, maximum 3.68kVA PV plant is limited. The grid protection report and setting are readable from the gateway. For grid code G83/2, maximum 16A per phase is limited. The grid protection report and setting are readable from the gateway.		

MODEL		BDM-250-LV
INPUT(DC)	Max Recommended PV Power (Wp)	285
	Vmax PV (absolute maximum) (Vdc)	60
	PV Input Operating Voltage Range (Vdc)	22-55
	Maximum Operating PV Input Current (Adc)	12
	MPPT Tracking Accuracy	>99.5%
	Isc PV (absolute maximum) (Adc)	14
	Maximum Inverter Backfeed Current to the Array (Adc)	0
OUTPUT(AC)	Rated AC Output Power (W)	220
	Nominal Power Grid Voltage (Vac)	127
	Current (maximum continuous) (Aac)	1.73
	Current (inrush) (Peak and Duration)	12A, 15us
	Nominal Frequency (Hz)	60
	Power Factor (cos phi, fixed)	>0.99
	Maximum Output Fault Current (Aac)	4.2A peak
	Maximum Output Overcurrent Protection (Aac)	10
	Maximum Number of Units Per Branch	8
SYSTEM EFFICIENCY	Peak Efficiency	96.30%
	CEC Efficiency	95.0%
	Night Time Tare Loss (Wp)	0.17
PROTECTION FUNCTIONS	Over/Under Voltage Protection	Yes
	Over/Under Frequency Protection	Yes
	Anti-Islanding Protection	Yes
	Over Current Protection	Yes
	Reverse DC Polarity Protection	Yes
	Overload Protection	Yes
	GFDI	Integrated
	Protective Class	I
IP Rating per Part 1	IP67	
OTHER PARAMETERS	Environment Temperature	-40°C ~ +65°C
	Environment Category	Indoor and outdoor
	Wet Location	SUITABLE
	Pollution Degree	PD 3
	Environment Humidity	100% condensation
	Maximum Altitude	2000 M
	Overvoltage Category	II(PV), III (AC MAINS)
	Display	LED LIGHT
	Communications	POWERLINE
	Dimension (D-W-H mm)	230*138*35
	Weight(Kg)	2
	Product Safety Compliance	UL 1741 CSA C22.2 No. 107.1
	Grid Code Compliance* (Refer to the label for the detailed grid code compliance)	IEEE 1547

9. WARRANTY AND PRODUCTION INFORMATION

What does this warranty cover and how long does it last?

This Limited Warranty is provided by Northern Electric & Power Co. Ltd (NEP) and covers defects in workmanship and materials in your BDM-250 Grid-Tied Inverter.

This Limited Warranty is transferable to subsequent owners but only for the unexpired portion of the Warranty Period. Subsequent owners also require original proof of purchase as described in "What proof of purchase is required?"

What will NEP do?

During the Warranty Period, NEP will, at its option, repair the product (if economically feasible) or replace the defective product free of charge, provided that you notify NEP of the product defect within the Warranty Period, and provided that NEP through inspection establishes the existence of such a defect and that it is covered by this Limited Warranty.

NEP will, at its option, use new and/or reconditioned parts in performing warranty repair and building replacement products. NEP reserves the right to use parts or products of original or improved design in the repair or replacement. NEP repairs or replaces a product, its warranty continues for the remaining portion of the original Warranty Period or 90 days from the date of the return shipment to the customer, whichever is greater. All replaced products and all parts removed from repaired products become the property of NEP.

How do you get service?

If your product requires troubleshooting or warranty service, contact your merchant. If you are unable to contact your merchant, or the merchant is unable to provide service, contact NEP directly at:

Northern Electric & Power Co. Ltd

Address: NO.1 Anhe Rd Tsingtao Export Processing Zone, Tsingtao, China 266113

Phone: +86 532 87963900

Fax: +86 532 81100917

What does this warranty not cover?

Claims are limited to repair and replacement or if in NEP's discretion that is not possible, reimbursement up to the purchase price paid for the product. NEP will be liable to you only for direct damages suffered by you and only up to a maximum amount equal to the purchase price of the product.

This Limited Warranty does not warrant uninterrupted or error-free operation of the product or cover normal wear and tear of the product or costs related to the removal, installation, or troubleshooting of the customer's electrical systems. This warranty

does not apply to and NEP will not be responsible for any defect in or damage to: a) the product if it has been misused, neglected, improperly installed, physically damaged or altered, either internally or externally, or damaged from improper use or use in an unsuitable environment; b) the product if it has been subjected to fire, water, generalized corrosion, biological infestations, or input voltage that creates operating conditions beyond the maximum or minimum limits listed in the NEP product specifications including high input voltage from generators and lightning strikes; c) the product if repairs have been done to it other than by NEP or its authorized service centers (hereafter "ASCs"); d) the product if it is used as a component part of a product expressly warranted by another manufacturer; e) the product if its original identification (trade-mark, serial number) markings have been defaced, altered, or removed; f) the product if it is located outside of the country where it was purchased; and g) any consequential losses that are attributable to the product losing power whether by product malfunction, installation error or misuse.

Disclaimer Product

THIS LIMITED WARRANTY IS THE SOLE AND EXCLUSIVE WARRANTY PROVIDED BY NEP IN CONNECTION WITH YOUR NEP PRODUCT AND IS, WHERE PERMITTED BY LAW, IN LIEU OF ALL OTHER WARRANTIES, CONDITIONS, GUARANTEES, REPRESENTATIONS, OBLIGATIONS AND LIABILITIES, EXPRESS OR IMPLIED, STATUTORY OR OTHERWISE IN CONNECTION WITH THE PRODUCT, HOWEVER ARISING (WHETHER BY CONTRACT, TORT, NEGLIGENCE, PRINCIPLES OF MANUFACTURER'S LIABILITY, OPERATION OF LAW, CONDUCT, STATEMENT OR OTHERWISE), INCLUDING WITHOUT RESTRICTION ANY IMPLIED WARRANTY OR CONDITION OF QUALITY, MERCHANTABILITY OR FITNESS FOR A PARTICULAR PURPOSE. ANY IMPLIED WARRANTY OF MERCHANTABILITY OR FITNESS FOR A PARTICULAR PURPOSE TO THE EXTENT REQUIRED UNDER APPLICABLE LAW TO APPLY TO THE PRODUCT SHALL BE LIMITED IN DURATION TO THE PERIOD STIPULATED UNDER THIS LIMITED WARRANTY.

IN NO EVENT WILL NEP BE LIABLE FOR: (a) ANY SPECIAL, INDIRECT, INCIDENTAL OR CONSEQUENTIAL DAMAGES, INCLUDING LOST PROFITS, LOST REVENUES, FAILURE TO REALIZE EXPECTED SAVINGS, OR OTHER COMMERCIAL OR ECONOMIC LOSSES OF ANY KIND, EVEN IF NEP HAS BEEN ADVISED, OR HAD REASON TO KNOW, OF THE POSSIBILITY OF SUCH DAMAGE, (b) ANY LIABILITY ARISING IN TORT, WHETHER OR NOT ARISING OUT OF NEP'S NEGLIGENCE, AND ALL LOSSES OR DAMAGES TO ANY PROPERTY OR FOR ANY PERSONAL INJURY OR ECONOMIC LOSS OR DAMAGE CAUSED BY THE CONNECTION OF A PRODUCT TO ANY OTHER DEVICE OR SYSTEM, AND (c) ANY DAMAGE OR INJURY ARISING FROM OR AS A RESULT OF MISUSE OR ABUSE, OR THE INCORRECT INSTALLATION, INTEGRATION OR OPERATION OF THE PRODUCT.

IF YOU ARE A CONSUMER (RATHER THAN A PURCHASER OF THE PRODUCT IN THE COURSE OF A BUSINESS) AND PURCHASED THE PRODUCT IN A MEMBER STATE OF THE EUROPEAN UNION, THIS LIMITED WARRANTY SHALL BE SUBJECT TO YOUR STATUTORY RIGHTS AS A CONSUMER UNDER THE EUROPEAN UNION PRODUCT WARRANTY DIRECTIVE 1999/44/EC AND AS SUCH DIRECTIVE HAS BEEN IMPLEMENTED IN THE EUROPEAN UNION MEMBER STATE WHERE YOU PURCHASED THE PRODUCT. FURTHER, WHILE THIS LIMITED WARRANTY GIVES YOU SPECIFIC LEGAL RIGHTS, YOU MAY HAVE OTHER RIGHTS WHICH MAY VARY FROM EU MEMBER STATE TO EU MEMBER STATE OR, IF YOU DID NOT PURCHASE THE PRODUCT IN AN EU MEMBER STATE, IN THE COUNTRY YOU PURCHASED THE PRODUCT WHICH MAY VARY FROM COUNTRY TO COUNTRY AND JURISDICTION TO JURISDICTION.

Warranty Card

Customer Information

Name: _____

Address: _____

City: _____ State: _____ Zip Code: _____

Tel: _____ Fax: _____ E-mail: _____

System Information

Fault Product(s) Serial Numbers: _____

System Commissioning Date: _____ Product Models: _____

No. of Products Used: _____ Bill of Lading Date: _____

Fault Product(s) Quantities: _____ Fault Time/Date: _____

Fault Message(s) or Code(s): _____

Brief Fault Description and Photos:

Installation Information

Modules Used: _____

Modules Quantity: _____ Inverters quantity per string: _____

Installation Company Name: _____

Installer Name: _____

For the information on our warranty terms and conditions, please see our website: www.northernep.com/en
All fields must be completed in order to process claim.

Customer Signature: _____ Date: _____

*All rights reserved by NEP. This information is subject to changes without notice.





USA

Add: 1781 Riverview Ave., Tracy, CA 95377

Australia

Address: 9 Meander Grove, Cameron Park, NSW2285

China

Add: No.1 Anhe Rd Tsingtao Export Processing Zone, Tsingtao, China 266113

TEL: +86 532 87963900

FAX: +86 532 81100917